

Hireable Rooms at St Anne's House

Information pack

Version 01
September 2023



**ST
ANNE'S
HOUSE**

St Anne's House
St Anne's Rd
BS4 4AB, Bristol

www.stanneshouse.org
[@bricksbristol](https://twitter.com/bricksbristol)
stannes@bricksbristol.org
07709264 201

Welcome to St Anne's House

In this information pack you can find the different rooms we have available for hire in Brislington, Bristol. If cost is a barrier for your group or event, please get in touch.

ROOMS	PRICE	CAPACITY	DIMENSIONS
MILL ROOM	£25/ph	Max 110	15.4m [L] x 7m [w]
PULP ROOM	£25/ph	Max 110	19m [L] x 4.5m [w]

These terms are subject to change, check with Bricks team to ensure you are looking at the latest update.

Room location

All hireable rooms are on the ground floor

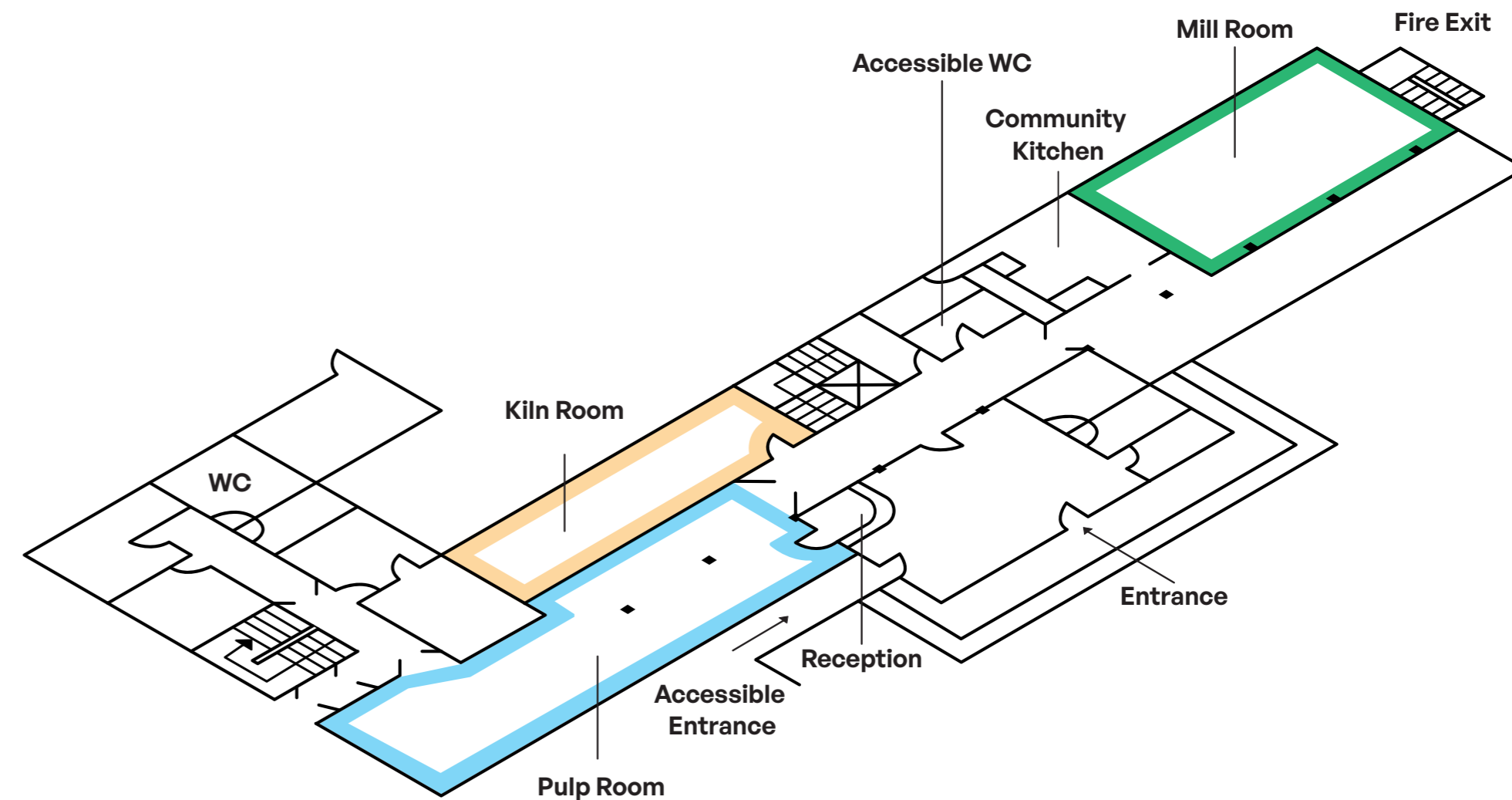

Building Accessibility

St Anne's House is equipped with accessible amenities, ensuring a welcoming environment for all. It offers convenient parking, ramps for easy access, wide doors, inclusive toilets, clear signage, and accessible sinks.

Arriving and entering the building

- 4 dedicated disabled parking spaces next to the entrance
- Entrance is accessible via ramp and accessible electric door
- Hearing loop
- Seating in reception
- Accessible toilet
- Lift that accesses all floors Width 75cm x Depth 145cm
- The ground floor kitchen has a low access sink



Travel to us

Address: St Anne's House, St Anne's Road, Brislington, BS4 4AB
Located just off St Anne's Road, we are nestled in between Netham Park and St Anne's Woods.

The best ways to travel to us include

From Temple Meads Train Station (Central Bristol)

- Walking: 35 minutes
- Cycling: 9 minutes
- E-Scooter: 9 minutes
- Driving: 8 minutes
- Bus: Number 36

You could also request a bus using the West Link which will drop you off across the road from us.

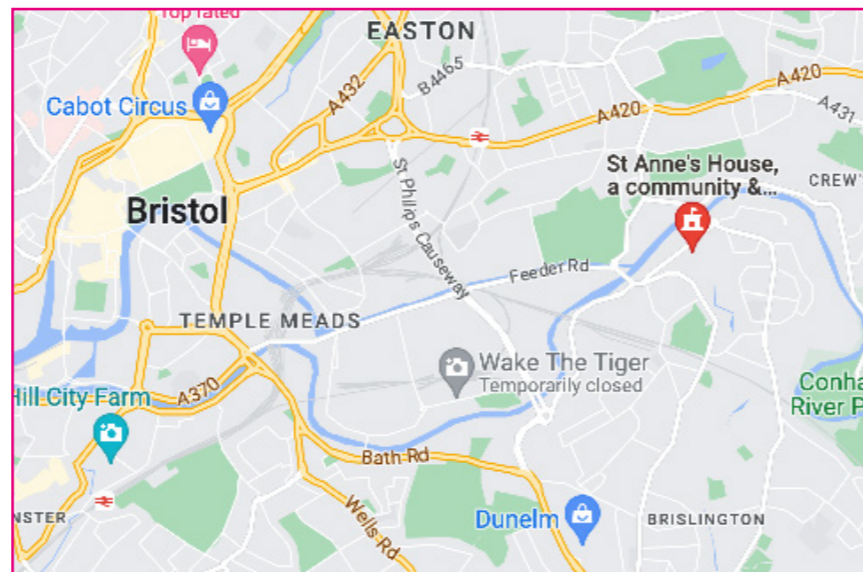

Mill Room



Mill Room

Our large ground floor room is perfect for family parties, conferences and training sessions, and community focused events.

The room is very versatile and has previously been hired out by choirs, orchestras, film screenings, yoga classes, large hybrid conferences, and more.

£25/ph
Max 110
15.4m x 7m
Includes available chairs and tables.
You can hire additional equipment (see page 18 for options).

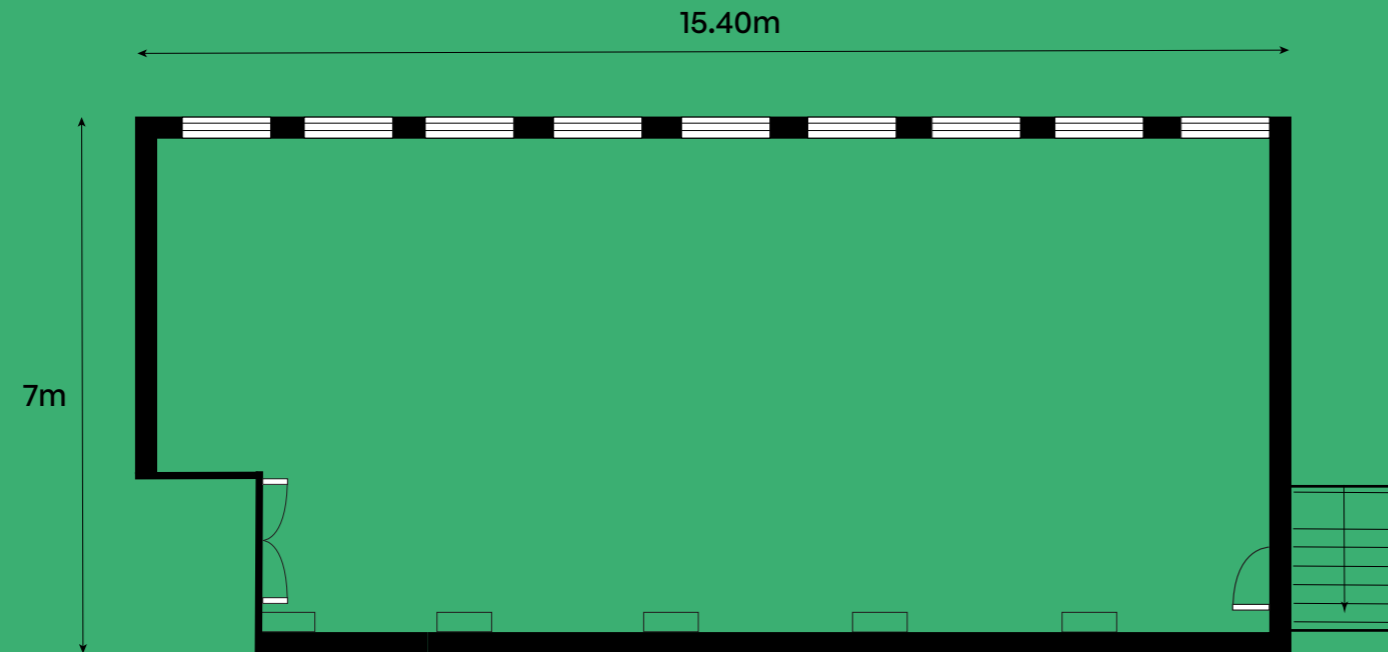

Floor Plan

Ground Floor
Mill Room

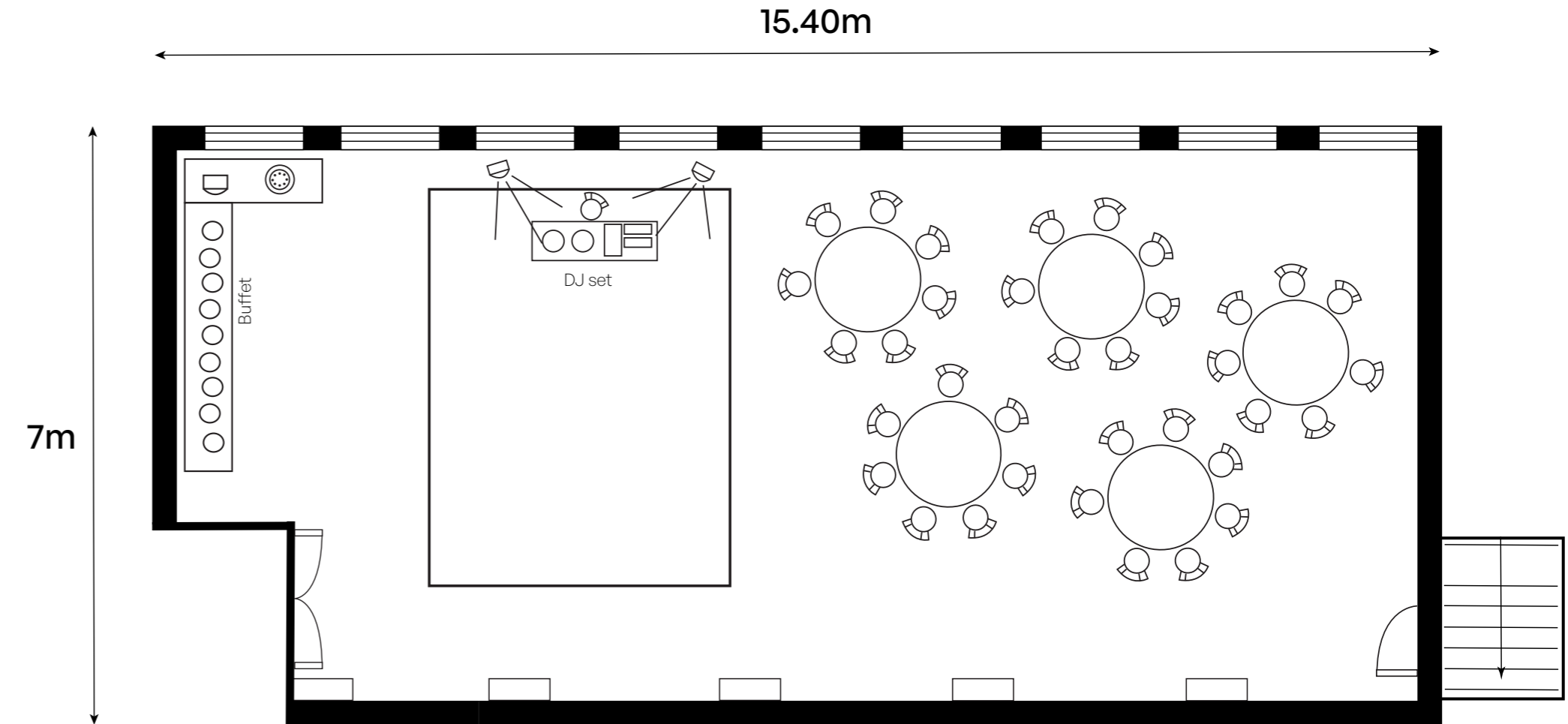

Floor Plan

Ground Floor
Mill Room

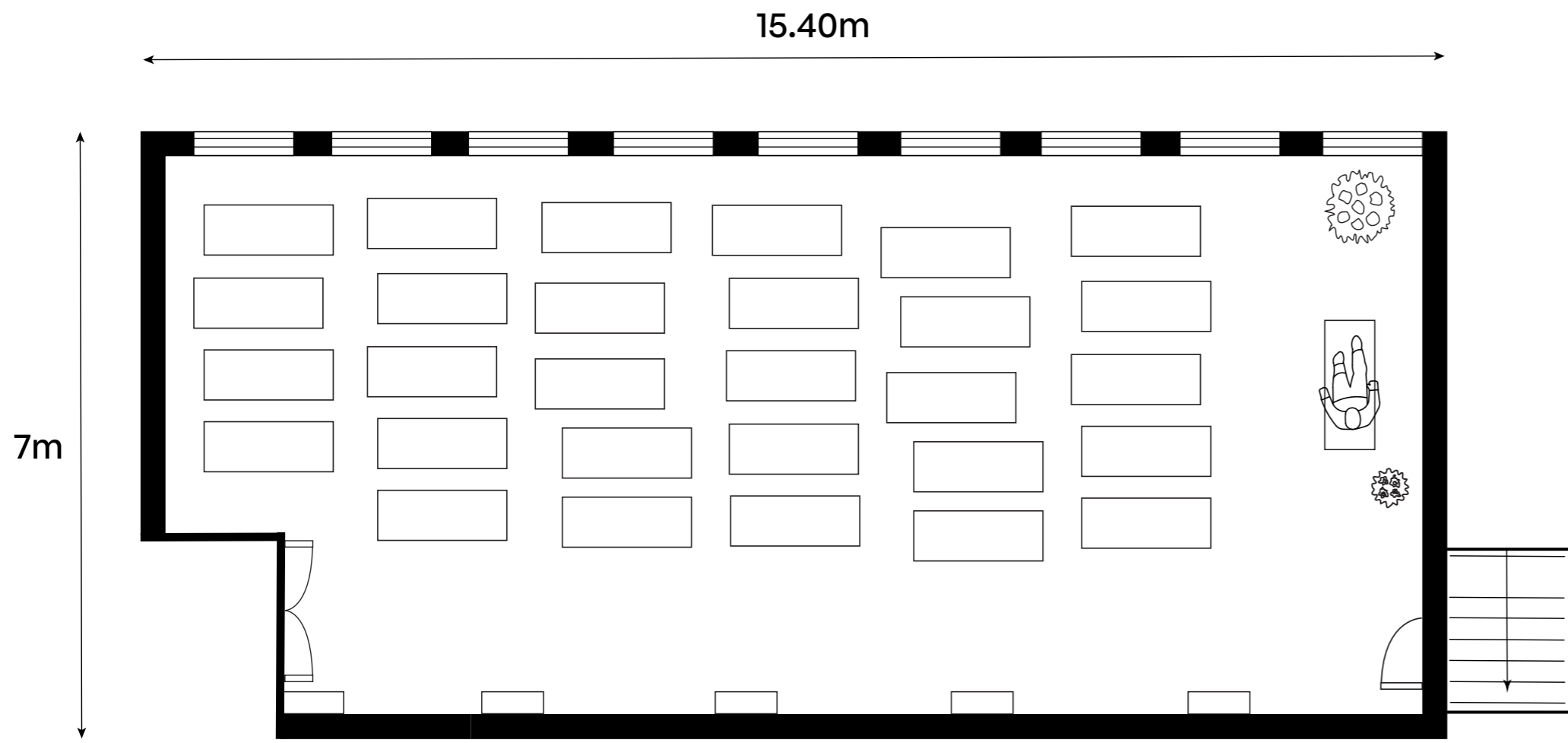

Floor Plan

Ground Floor
Mill Room



Pulp Room

Our largest room is the perfect event space. With plenty of natural light, a big capacity, and the option to add the Kiln room as a 'back of house' space, storage area or green room, this room is a perfect blank canvas for your event, team day, performance or exhibition. Talk to us about deals for longer term hires.

£25/ph

Max 110

19m x 4.5m

Includes available chairs and tables.

You can hire additional equipment (see page 18 for options).

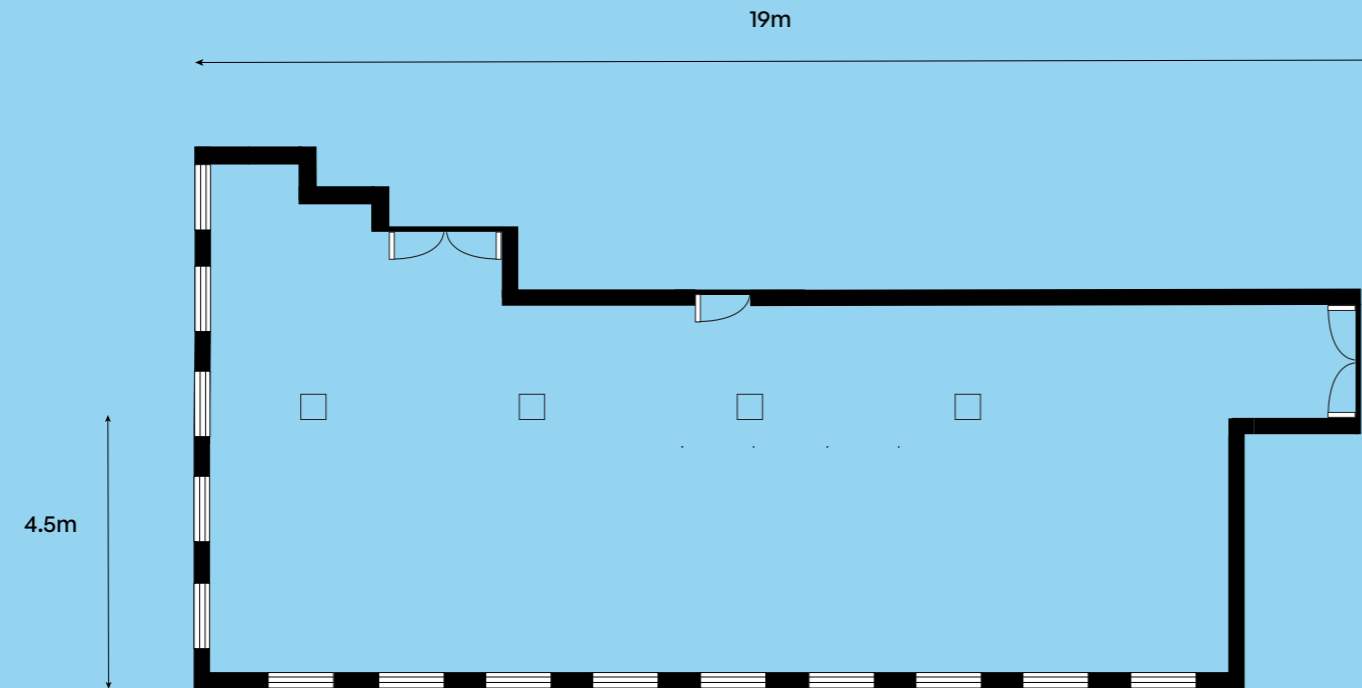

Floor Plan

Ground Floor
Pulp Room

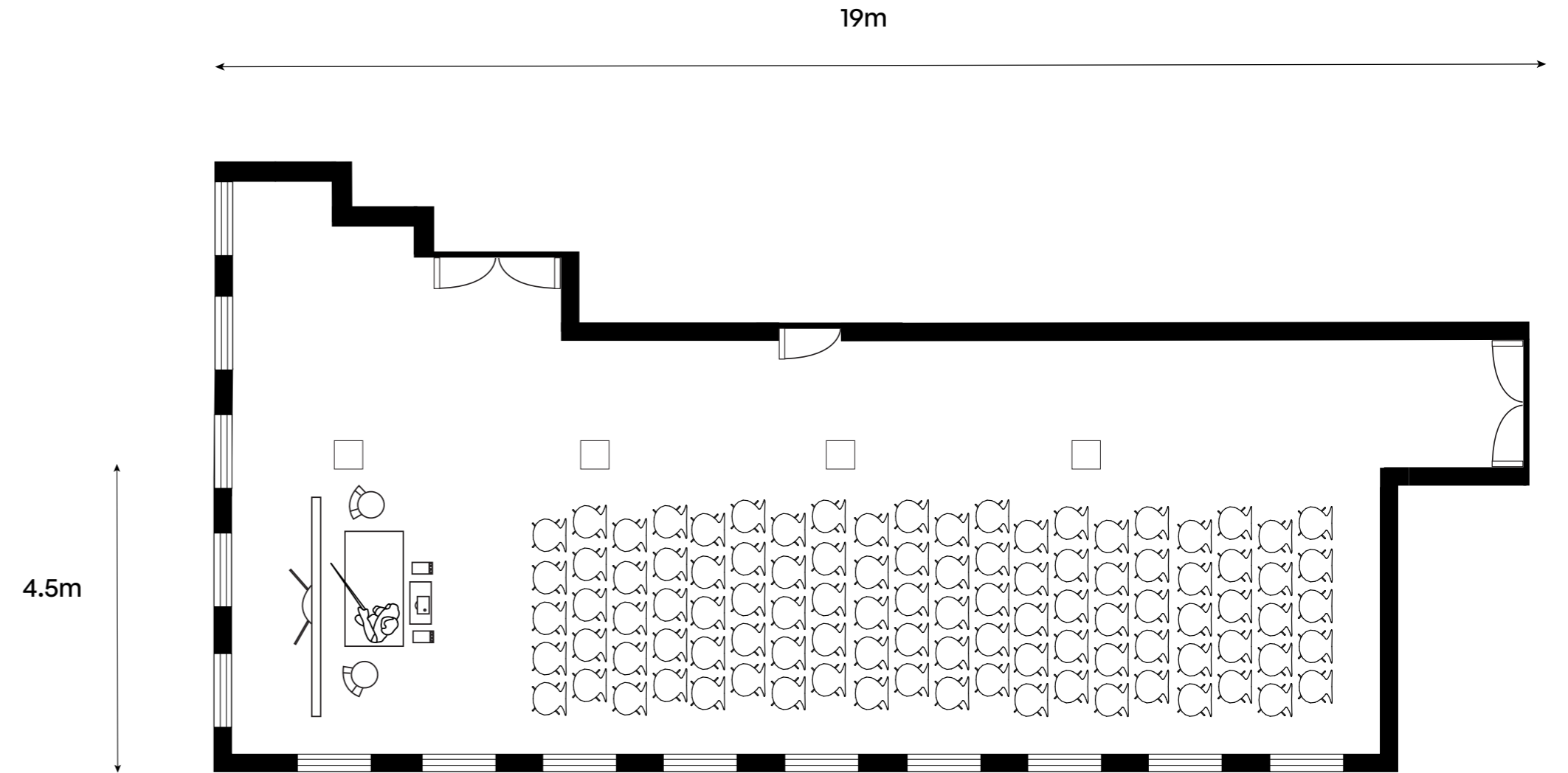

Floor Plan

Ground Floor
Pulp Room

19m

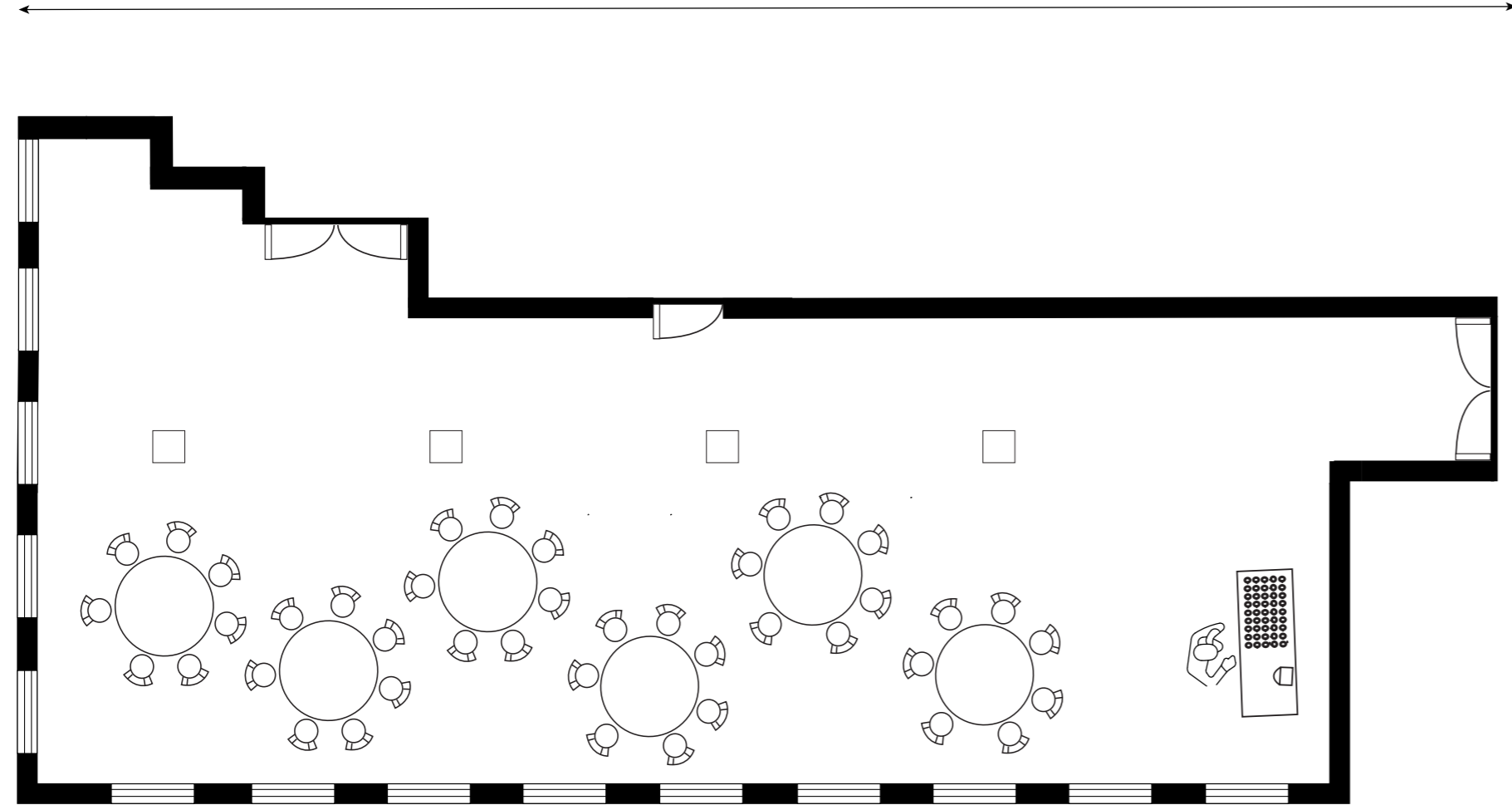

4.5m

Floor Plan

Ground Floor
Pulp Room

Refreshments

Selection of tea and coffee, herbal teas, dairy or oat milk & biscuits
Price: £1.50 per head

Catering
If you need sandwiches delivered we can recommend some local options. Please get in touch to talk about your requirements.

Community Kitchen
Adjacent to the Paper and Mill rooms is our kitchen space. This area is in development, and we hope to have a fully equipped community kitchen for hire in the near future.

In the meantime, the space has worktops, sinks, microwave, and an oven, and fridge space can be made available. It can be hired for simple cooking or prep activities for £10/hour.



Additional equipment list

A/V Equipment	Price
Optoma UHD35 Projector	£10
Projector screens (various sizes available)	£5
JBL Sound Bar 2.0	£5
PA system with x 2 wireless microphones	£10
PA system with mixing desk and speakers	£20
Large PA systems with mixing desk and speakers	£5
Behringer Xenyx X2442USB Analog Mixer	£2.5
Audio RMX 2450 Power Amplifier	£2.5
Audio RMX 850 Power Amplifier	£2.5

Furniture options (no fee) please book in advance

Chairs of various styles x +100	
Large round table (length 168cm, height 77cm) x 6	
Small workshop table (length 92cm, width 61.5cm, height 73cm) x 1	
Small workshop table (length 120cm, width 60cm, height 70cm) x 5	

Other

40mm EVA Foam Jigsaw Mats	£30
Flip chart stand and paper including pens	£5

Please book these in advance through the enquiry form

Enquire today

Please fill in the form [here](#)

Or visit our webpage: stanneshouse.org/get-involved/book-a-room

You can directly contact with any questions:

stannes@bricksbristol.org // [07709 264 201](tel:07709264201)

